

# MUJIE 慕杰®

YOUR AUTOMATION, YOUR MUJIE!

高速感应，多孔径可选，IP67  
防护等级，无死角检测金属物体

环形MO电感式接近传感器  
Annular Mo inductive proximity sensor

High speed induction, multi aperture  
optional, IP67 protection grade, no  
dead corner detection of metal objects

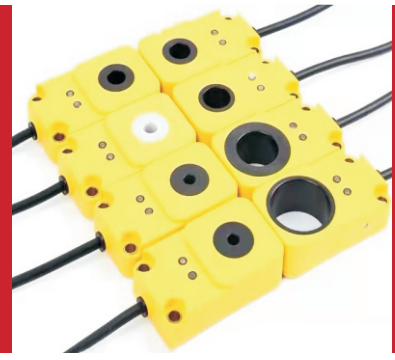

## 型号说明 Model Explanation

M	O	25/40	-06	N	K	-Z
基本型号Model M-型号代码 Model code M□: 特殊型号定义 Special definition	传感器类别 Category: O:环形电感式 Ring inductance type	产品尺寸 Product size	孔径 aperture: 03:03mm 06:06mm 08:08mm 10:10mm 12:12mm 14:14mm 20:20mm 30:30mm	输出方式 Output mode: N:NPN输出 P:PNP输出	输出状态 Operation mode: K:常开 NO B:常闭 NC	产品等级 Product grade: Z:Z级

## 技术规格 Specification

型号 model	MO25-06NK-Z	MO40-06NK-Z
环直径 Ring diameter	6mm/10mm/12mm	3mm/6mm/8mm/10mm/12mm/14mm/20mm/30mm
安装 install	平面安装 Plane installation	
检测物体 Detection object	金属 Metal	
负载电流 Load current	200mA	
压降 Drop	< 2V	
消耗电流 Leakage current	< 10mA	
回差范围 Backlash	1~20% Sr	
重复精度 Repeat precision	< 3%	
响应时间 response time	DC:8ms, AC:50ms	
输出指示 Outout indication	红色LED Red LED	
极性保护 Polarity protection	Yes	
浪涌保护 Surge protection	Yes	
短路保护 Short circuit protection	Yes	
环境温度 Ambient temperature	-25.... +70°C	
环境湿度 Ambient humidity	35-95%RH	
防护等级 Degree of protection	IP67 ( IEC )	
外壳材料 Shell material	ABS	
连接方式 Connection mode	2m PVC 电缆 2m PVC cable	

## 电路输出方式(示例) Example for output circuit



## 安装尺寸图 Mounting Dimensions(单位Unit:mm)

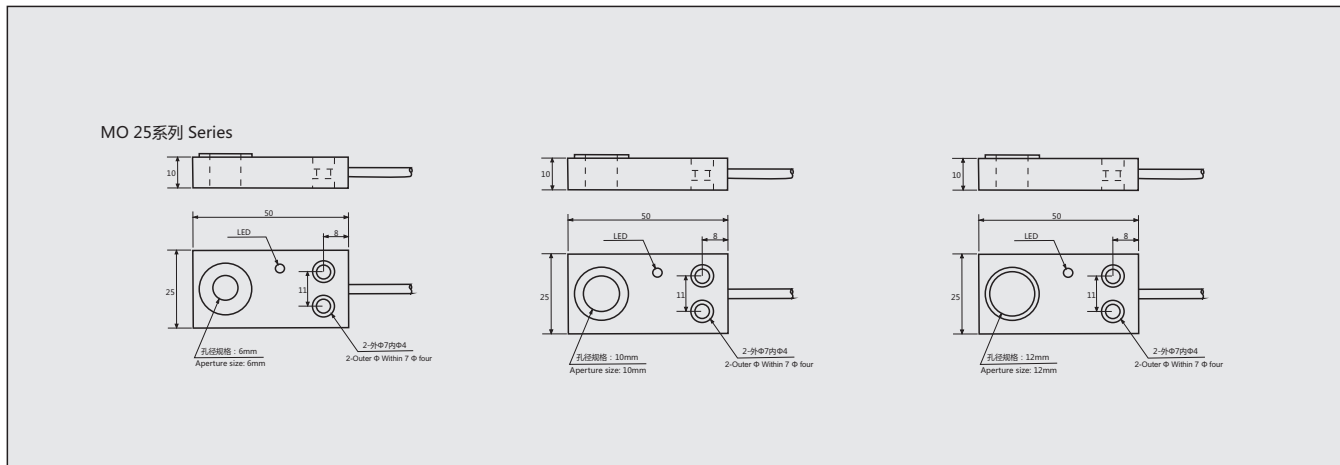

编码器/磁栅尺  
Encoder/Magnetic Scale

位移/倾角/计数器  
Displacement /Inclination /Counter

接近加速度/温度  
Proximity/Acceleration/Temperature

光电/超声波/区域  
Photoelectric/Ultrasonic/Area

压力/称重  
Pressure / load cell

联轴器/附件  
Couplings/Accessories

## ► 安装尺寸图 Mounting Dimensions(单位Unit:mm)

MO 40系列 Series

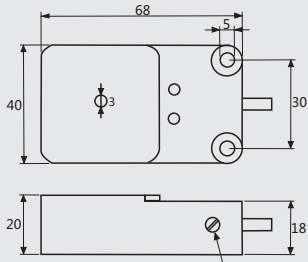

可调旋钮 Adjustable knob  
灵敏度调节 sensitivity modulation

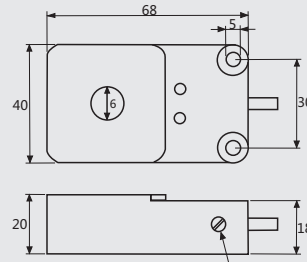

可调旋钮 Adjustable knob  
灵敏度调节 sensitivity modulation

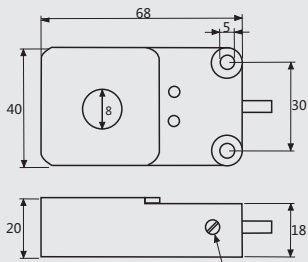

可调旋钮 Adjustable knob  
灵敏度调节 sensitivity modulation

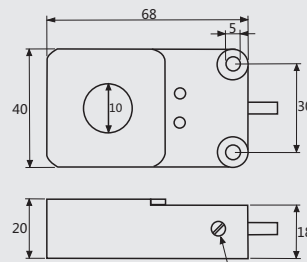

可调旋钮 Adjustable knob  
灵敏度调节 sensitivity modulation

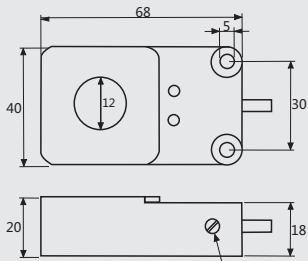

可调旋钮 Adjustable knob  
灵敏度调节 sensitivity modulation

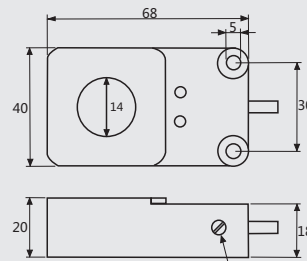

可调旋钮 Adjustable knob  
灵敏度调节 sensitivity modulation

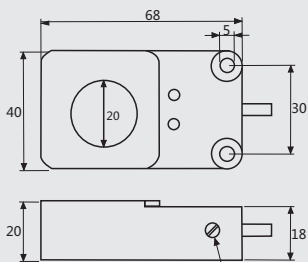

可调旋钮 Adjustable knob  
灵敏度调节 sensitivity modulation

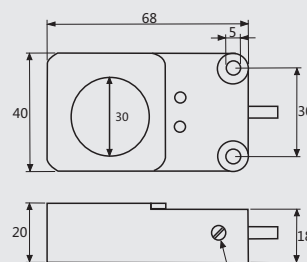

可调旋钮 Adjustable knob  
灵敏度调节 sensitivity modulation

编码器/磁栅尺  
Encoder/Magnetic Scale

位移/倾角/计数器  
Displacement /Inclination /Counter

接近/加速度/温度  
Proximity/Acceleration/Temperature

光电/超声波/区域  
Photoelectric/Ultrasonic/Area

压力/称重  
Pressure / load cell

联轴器/附件  
Couplings/Accessories